

Ten Years of OARC

Keith Mitchell

OARC

Fall Workshop & AGM

May 2015



DNS-OARC

Domain Name System Operations Analysis and Research Center

Time for reflection

- First OARC meeting was in fact in October 2004
- Paul Vixie's Original vision
- OARC is at least as relevant now as it was then, and seems to fill a long-term need
- What has our journey been since then ?



DNS-OARC

Domain Name System Operations Analysis and Research Center

DNS Abuse Motivation

- Microsoft outage in 2001
- DDoS attack on Root Servers 2002
- Open Resolvers since 2006
- DDoS attack on Root Servers Feb 2007
- Kaminsky “Summer of Fear” 2008
- IN ANY query attacks 2010-
- “StopHaus” DDoS attack 2013
- Random label attacks, ongoing...



DNS-OARC

Domain Name System Operations Analysis and Research Center

Root DDoS Attack, Feb 2007

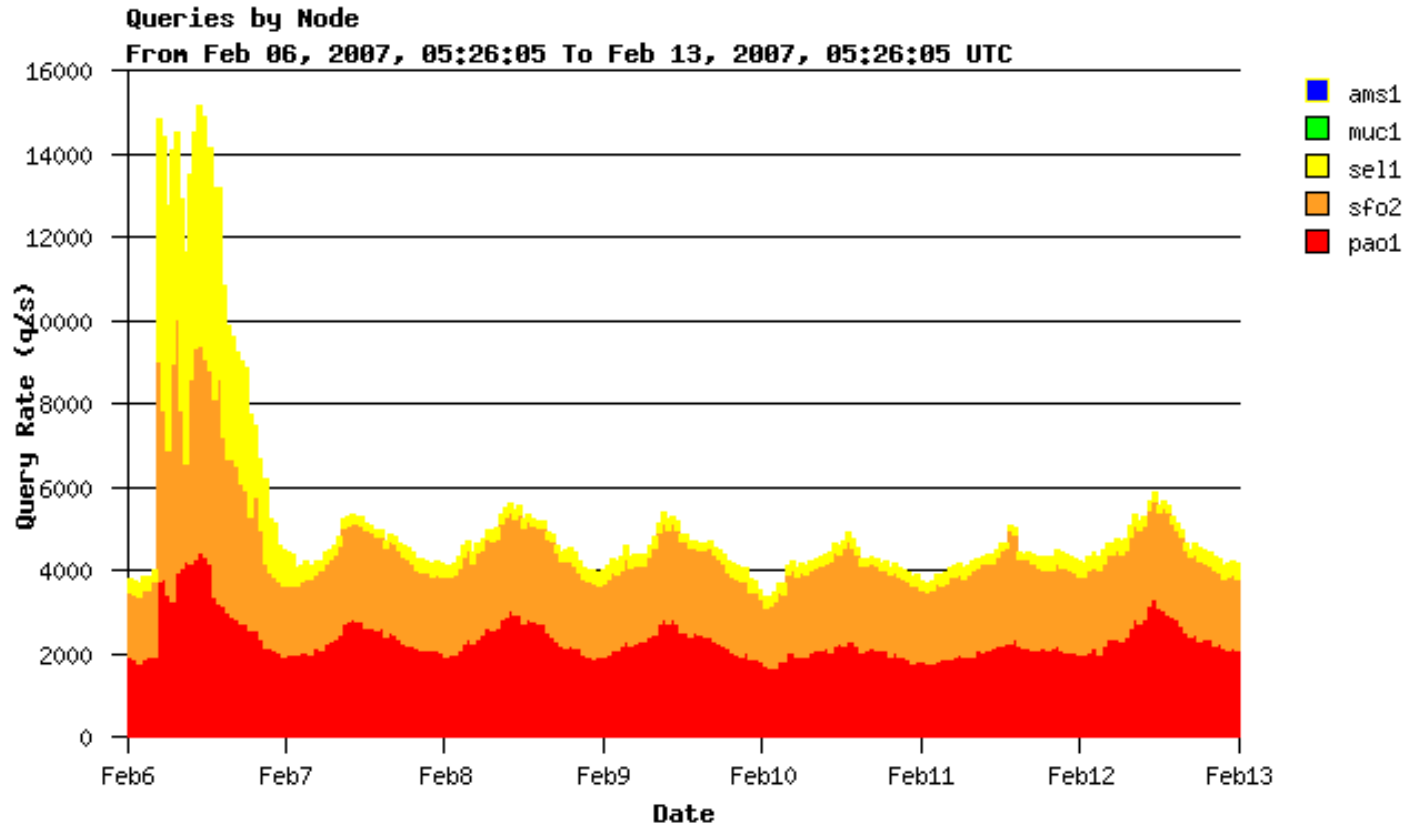

DNS-OARC

Domain Name System Operations Analysis and Research Center

Early OARC Instigators

- Brett Watson: collaboration study
- Suzanne Woolf: secretariat
- Dave Knight: file server
- Michael Graff: portal software
- Duane Wessels: data collection software
- Geoff Sisson: DURZ and RZAIA studies



DNS-OARC

Domain Name System Operations Analysis and Research Center

Original Data Gathering Infrastructure

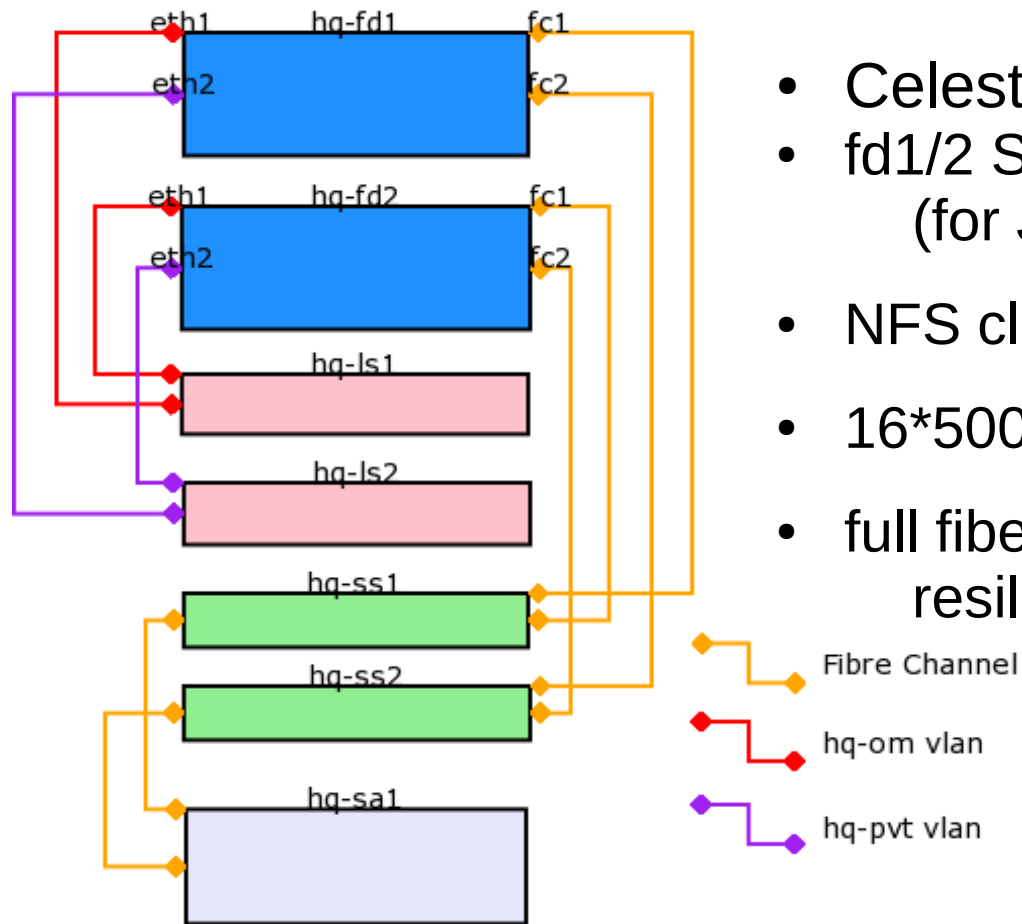

- Celestica Opteron Servers
- fd1/2 SuSE-10.1 Linux-based (for JFS support)
- NFS clients FreeBSD-based
- 16*500Gb SATA in RAID6
- full fiberchannel multipath resilience



DNS-OARC

Domain Name System Operations Analysis and Research Center

OARC Evolution

- Project within ISC 2004-2008
- Initial funding through NSFNET grant sub-contract from CAIDA
- I joined when I started at ISC in 2006
- Legal entity created 2008, Board elected
- 501(c)3 non-profit status achieved 2009
- Increasing autonomy over time



DNS-OARC

Domain Name System Operations Analysis and Research Center

Original Policy Council

- Gerry Sneeringer
- Matt Larson
- George Michaelson
- John Kristoff
- Andrew Sullivan



DNS-OARC

Domain Name System Operations Analysis and Research Center

Past OARC Board Members

- Matt Larson, 2008-12
- Dave Knight, 2008-09, 2014-
- Roy Arends, 2008-10
- Gerry Sneeringer, 2008-10
- Suzanne Woolf, 2010-13
- Stephane Bortzmeyer, 2010-12
- Peter Koch, 2008-13
- Matt Pounsett, 2009-14
- Antoin Verschuren, 2012-14
- Chris Griffiths, 2013-15

**THANK
YOU !!**



DNS-OARC

Domain Name System Operations Analysis and Research Center

Executive Directors

- Keith Mitchell, 2006-2008
- Duane Wessels, 2008-2010
- Wayne MacLaurin, 2010-2012
- Keith Mitchell, 2012-



DNS-OARC

Domain Name System Operations Analysis and Research Center

OARC's Data Set Over Time

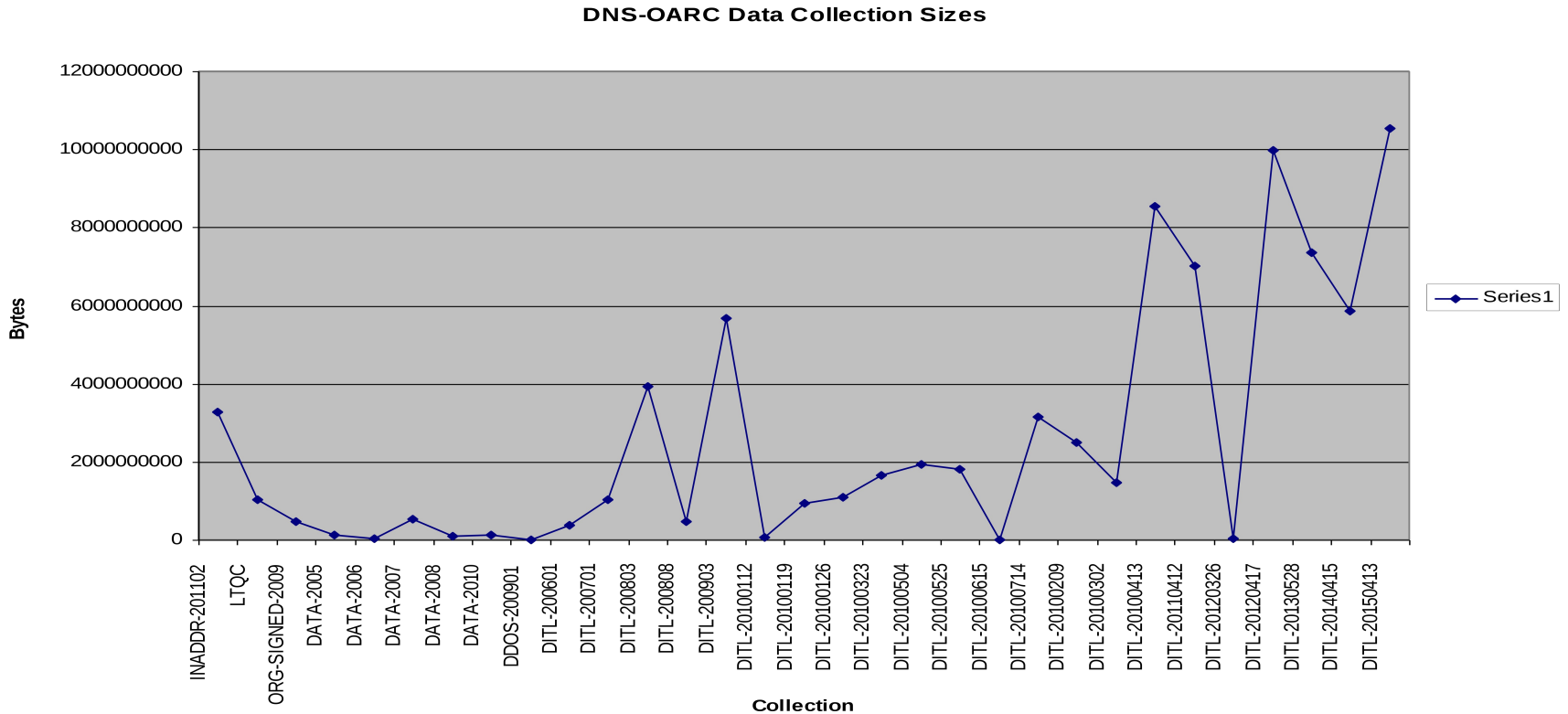

DNS-OARC

Domain Name System Operations Analysis and Research Center

DNS-OARC Per Meeting Attendee Growth

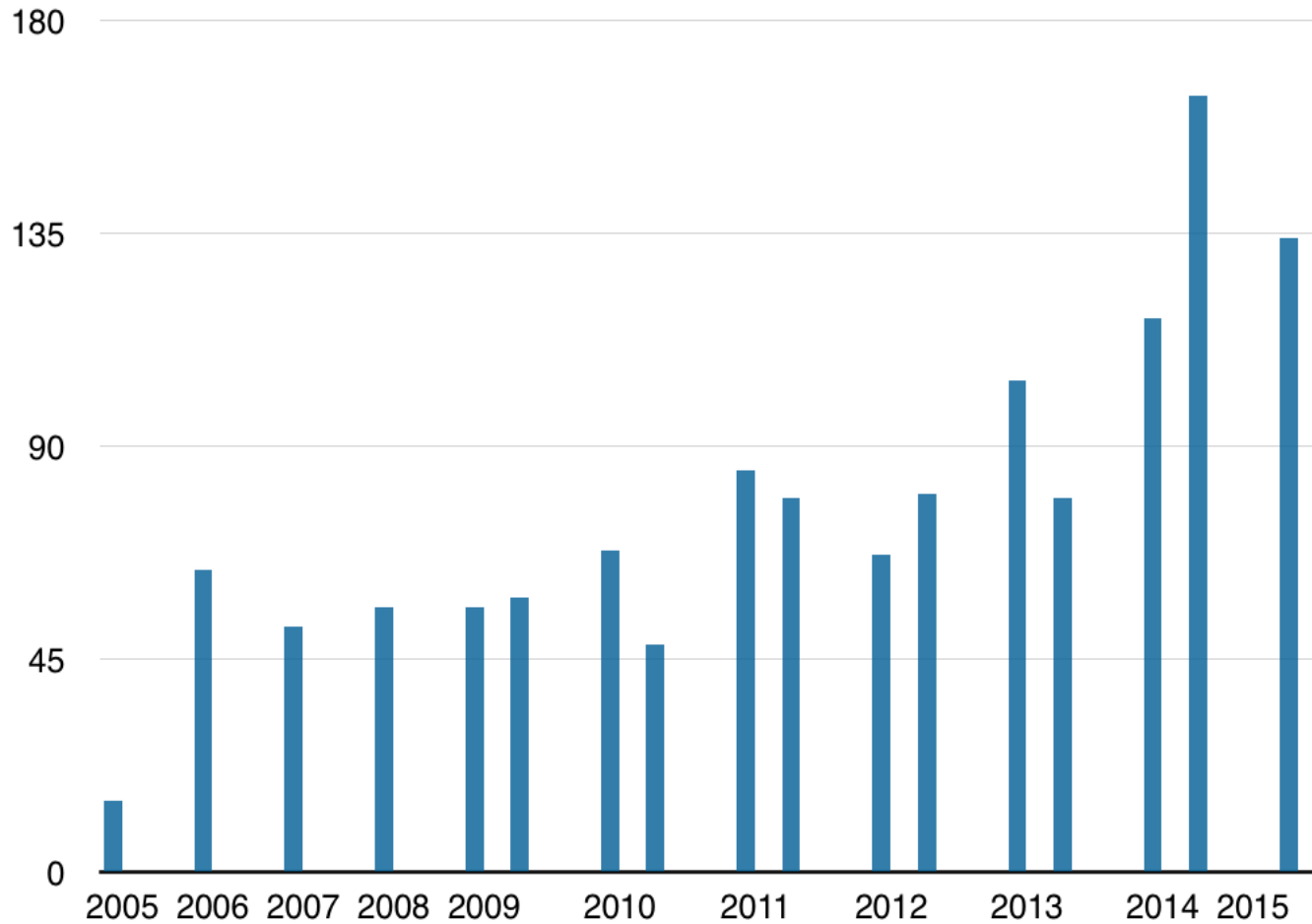

DNS-OARC

Domain Name System Operations Analysis and Research Center

Membership Growth

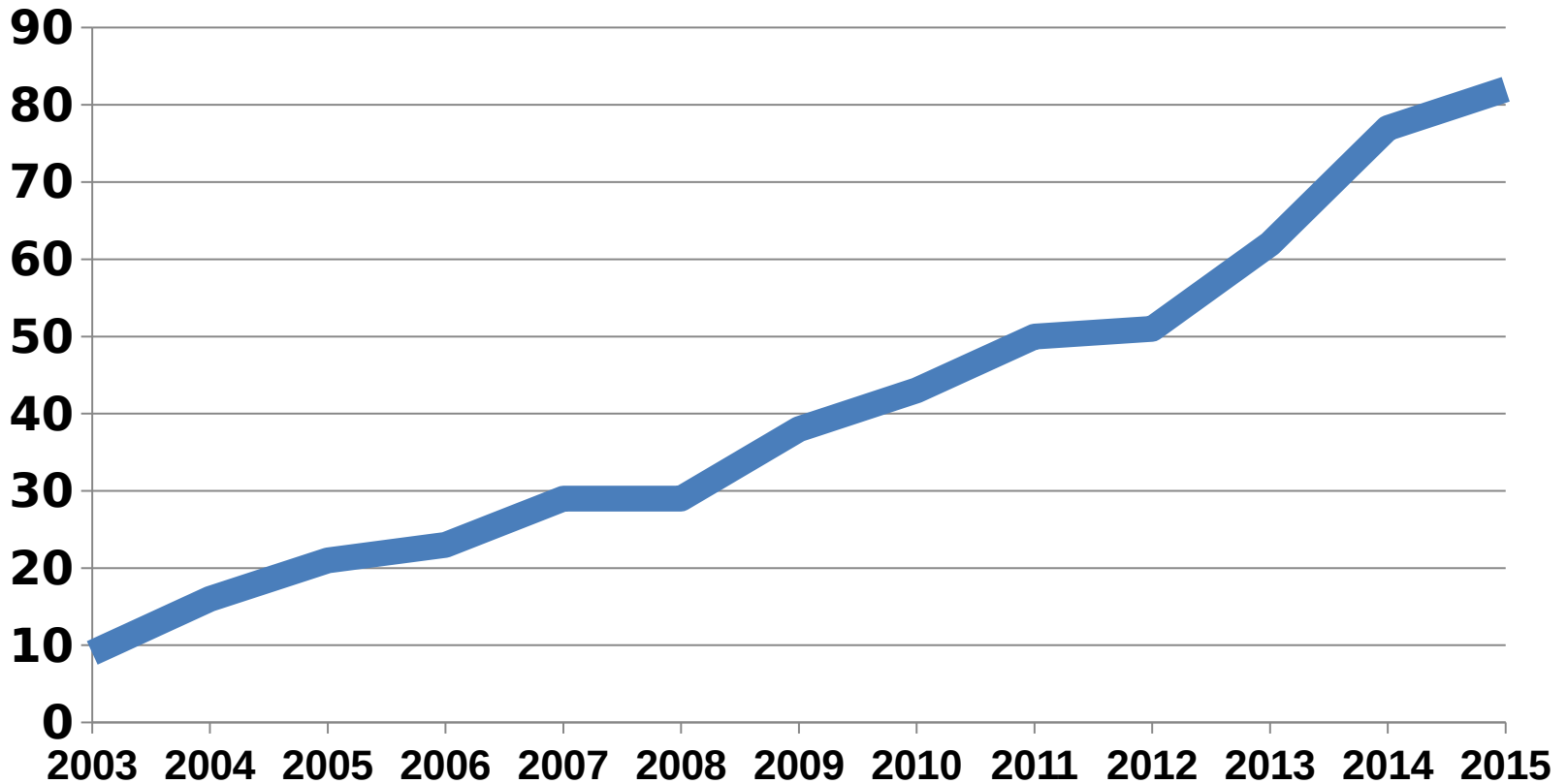

DNS-OARC

Domain Name System Operations Analysis and Research Center

Member vs Revenue Growth



Average Revenue \$ per Member

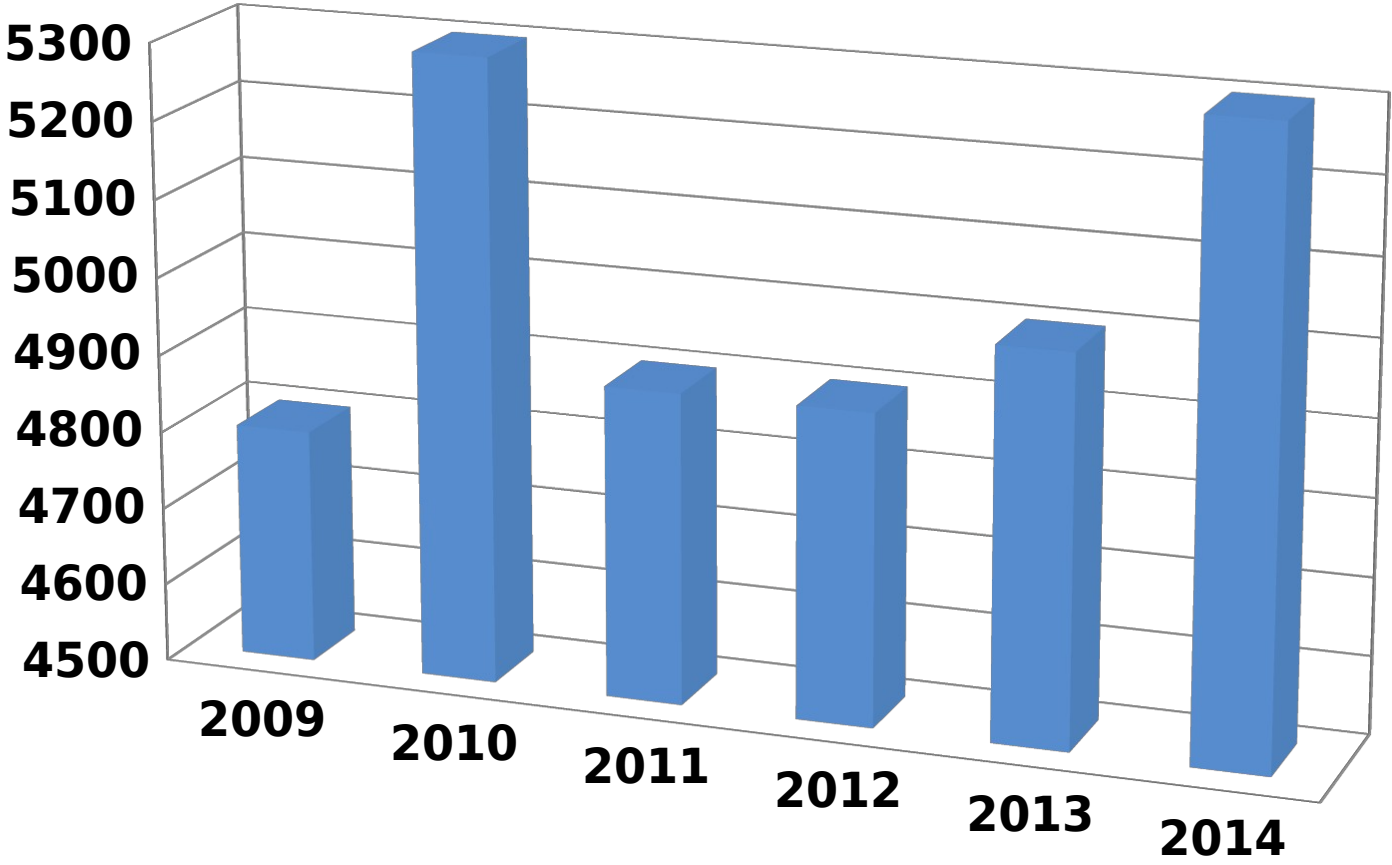

Where has OARC made a difference ?

- Kaminsky entropy tests
- Studies of Root Zone signing and IPv6
- Name Collisions study: *.corp, .home*
- Firefox ANY queries
- **Community Building.....**



DNS-OARC

Domain Name System Operations Analysis and Research Center

Platinum

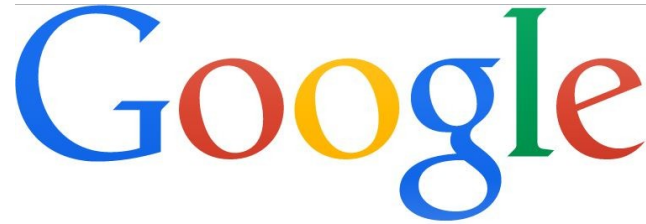

Gold

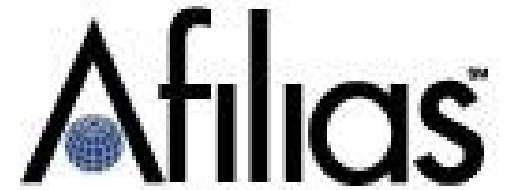

Silver

APNIC



CISCO™



neustar™



registro.br



Bronze



CHINA ORGANIZATIONAL NAME ADMINISTRATION CENTER
政务和公益机构域名注册管理中心

register.si 



.berlin



.se





Bronze



NIC MÉXICO



MarkMonitor®



Blue

NLnet

0001011011001110000101
00100001101001011100101
1011100000010100010100
0000101101110110101000
100110011000100111011
00100010001100100000
101001000100000110110

Labs

M³AAWG

MESSAGING MALWARE MOBILE

THANK YOU !!



DNS-OARC

Domain Name System Operations Analysis and Research Center